

HIGH PERFORMANCE BUTTERFLY VALVE HP 111



Wafer type butterfly valve in double-eccentric construction. Reliable sealing even with extreme temperature and pressure conditions.

TECHNICAL DATA

Nominal diameter:	DN 50 - DN 600 (larger nominal diameter on request)
Face-to-face:	EN 558 Series 20 (DIN 3202 T3 K1) ISO 5752 Series 20 (DIN 3202 T3 K1) API 609 Table 1 BS 5155 Series 4 NF E 29-305.1
Flange accommodation:	DIN 2501 PN 10/16/25/40 (to DN 150) DIN 2501 PN 10/16/25 (DN 200-DN 600) DIN 2632/33/34/35 ANSI B 16.5, Class 150 MSS SP44 Class 150 AWWA C 207 AS 2129 Table D and E BS 10 Table D and E JIS B 2211-5 K JIS 2212-10 K
Flange Surface Design:	DIN 2526, Form A-E, ANSI RF
Top flange:	EN ISO 5211 NF E 29-402
Marking:	DIN EN 19
Tightness check	
- for R-PTFE seat:	EN 12266 (Leakage rate A)
- for Inconel seat:	EN 12266 (Leakage rate B) ISO 5208, Category 3 API 598 Table 5 ANSI B 16-104, Class VI
Temperature range:	-196°C to +500°C (higher temperatures on request)
Differential pressure:	≤ DN150 max. 40 bar > DN150 max. 25 bar
Vacuum:	up to 0,2 bar absolute (depending on medium and temperature)

FEATURES

- Shut-off and control of gaseous and liquid media
- Disc and shaft have double-eccentric bearing
- Centering pieces can be used as installation aid
- Two seat ring systems available: R-PTFE and Inconel
- Seal variants:
 - soft-sealing (R-PTFE) max. 230°C
 - metallic sealing (Inconel) max. 450°C
- Maintenance-free
- Long service life, even at high switching frequencies

GENERAL APPLICATIONS

- Chemical and petrochemical industry
- Hot water and steam systems
- District heat supply
- Vacuum systems
- Shipbuilding
- Gas process technology
- Heavy duty services

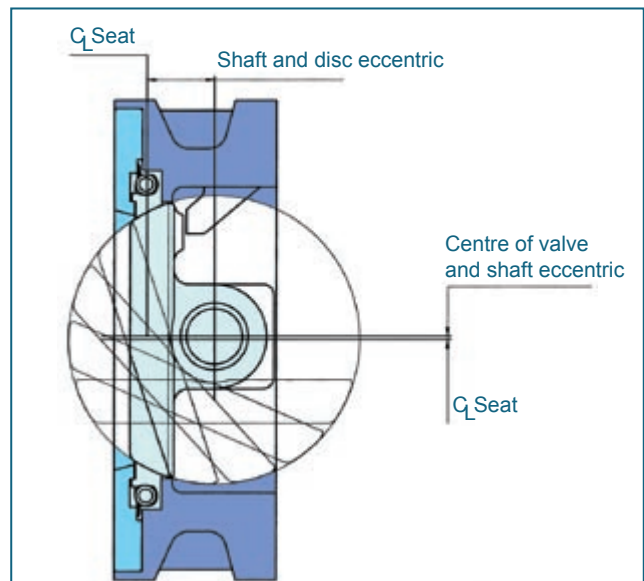

HIGH PERFORMANCE BUTTERFLY VALVE HP 111

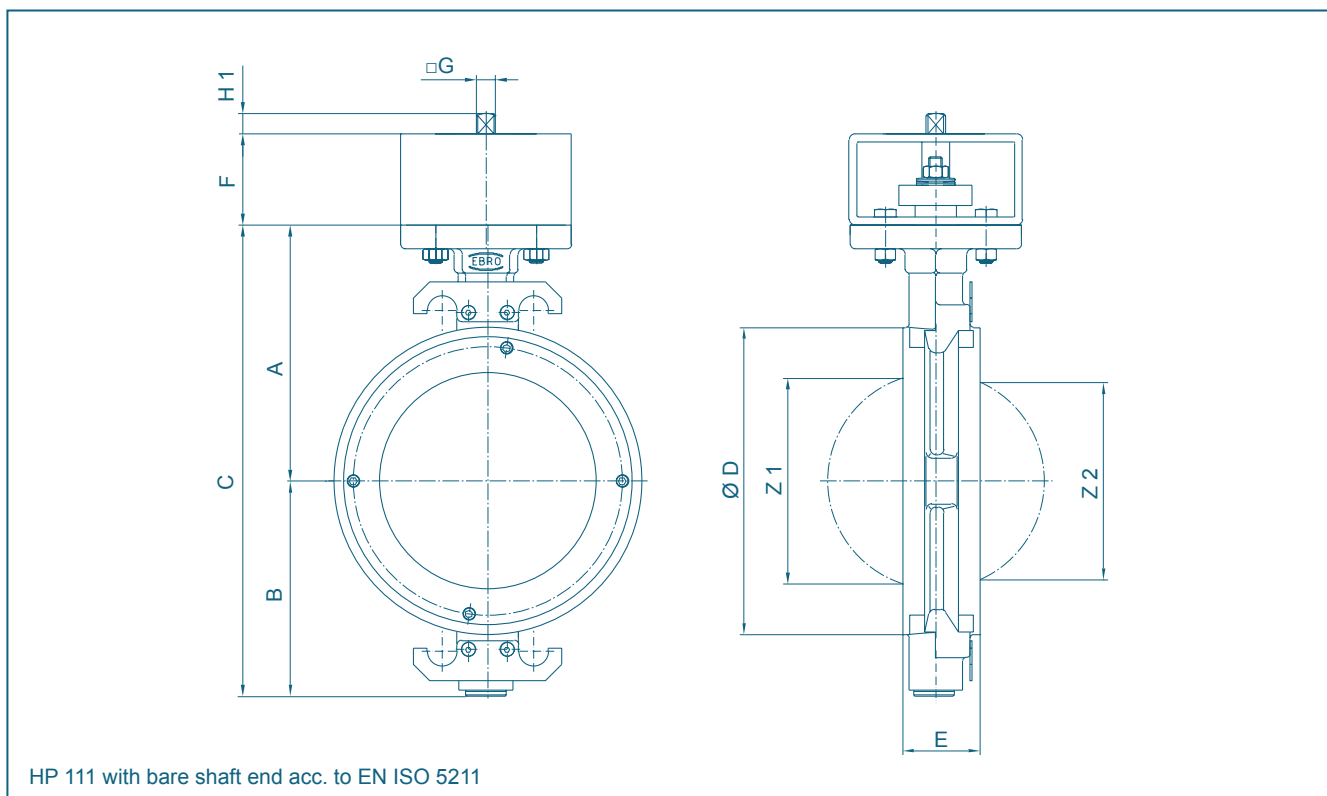

HP 111 with bare shaft end acc. to EN ISO 5211

DN [mm]	Size [in]	Dimensions [mm]											min. pipe-Ø	Weight [kg]
		A	B	C	D	E	F	Flange	G	H1	Z1	Z2		
50	2	133	99	232	112	43	80	F05	12	15	40,9	-	51	7,4
65	2½	133	99	232	112	43	80	F05	12	15	40,9	-	51	7,4
80	3	142	113	255	138	46	80	F05	12	15	70,7	54,4	80	8,0
100	4	158	124	282	160	52	80	F05	12	15	94,2	81,6	103	8,6
125	5	181	140	321	192	56	80	F07	14	18	114,5	105,3	124	12,6
150	6	195	154	349	216	56	80	F07	14	18	143,5	135,4	151	14,8
200	8	225	191	416	270	60	80	F10	17	18	187,4	181,2	196	22,9
250	10	268	222	490	326	68	80	F12	22	23	235,2	228,8	245	33,5
300	12	300	255	555	378	78	90	F12	27	28	280,7	275,8	296	48,0
350	14	345	304	649	438	92	100	F14	27	28	322,8	315,9	334	94,7
400	16	375	339	714	488	102	100	F14	36	36	371,6	363,9	385	115,0
450	18	412	340	752	530	114	120	F16	36	36	426,8	426,8	438	141,0
500	20	425	399	824	593	127	120	F16	46	46	468,7	466	484	186,0
550	22	456	405	861	635	154	200	F25	46	46	525,7	525,7	540	236,0
600	24	490	468	958	692	154	200	F25	55	55	544,2	542,2	560	310,0

Subject to change without notice

HIGH PERFORMANCE BUTTERFLY VALVE HP 111

MATERIAL SPECIFICATION AND PARTS LIST

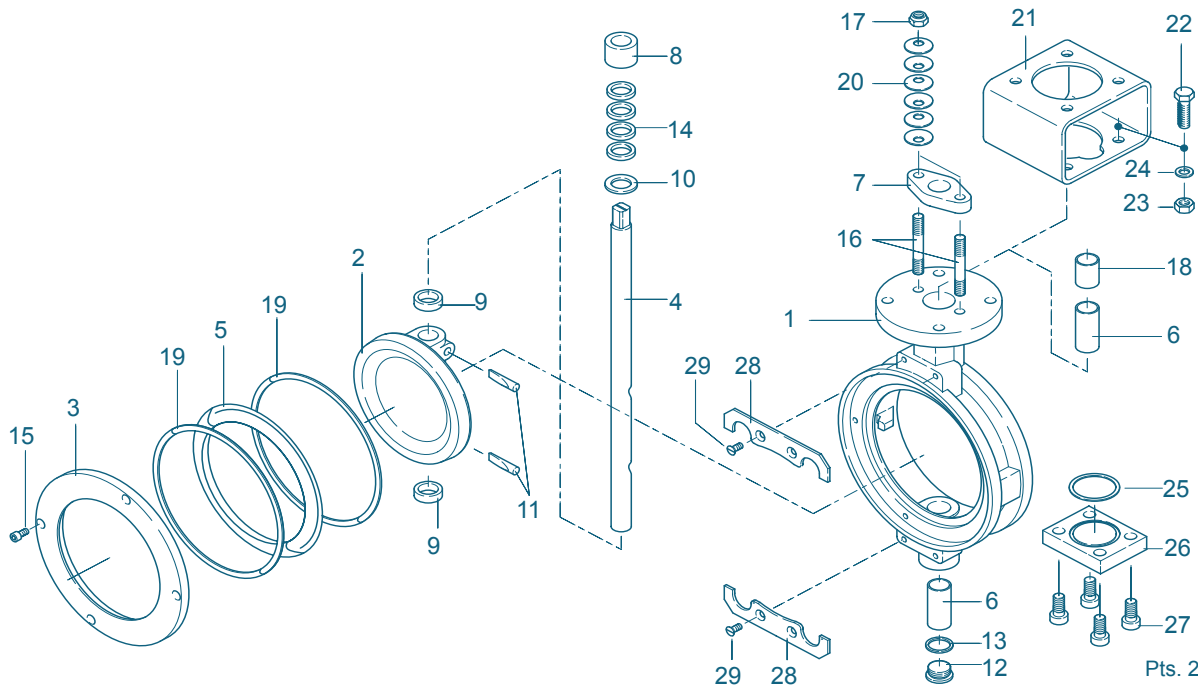

Pts. 25-27:
Cover plate for
valve ≥ DN 350

Pt.	Description	Material	Material No.	ASTM	Pt.	Description	Material	Material No.	ASTM
1	Body				14	Shaft seal			
	Carbon Steel	GS-C25N	1.0619	WCB		PTFE			
	Stainless Steel	G-X5CrNiMo19-11-2	1.4408	CF8M		Graphite			
2	Disc				15	Hex.-socket screw			
	Stainless Steel	G-X5CrNiMo19-11-2	1.4408	CF8M		Stainless Steel	A4-70	1.4401	B8M
3	Clamping ring				16	Threaded pin			
	Steel	St37-2	1.0037	283-C		Stainless Steel	A2-70	1.4301	B 8
	Stainless Steel	X5CrNiMo17-12-2	1.4401	316	17	Hex. nut			
4	Shaft					Stainless Steel	A 2	1.4301	8
	Stainless Steel	X4CrNiMo16-5-1	1.4418		18	Spacer sleeve			
5	Seat ring					Stainless Steel	X6CrNiMoTi17-12-2	1.4971	316 Ti
	R-PTFE	PTFE-Compound			19	Graphite seal (for metal seat)			
	Inconel	Inconel 625				Graphite			
6	Shaft bearing				20	Belleville spr. washer			
	Stainless Steel	X5CrNiMo17-12-2	1.4401/PTFE	316		Spring Steel	50CrV4	1.8159	6150
		X6CrNiMoTi17-12-2	1.4571 nitrite	316 Ti		Stainless Steel	X10CrNi18-8	1.4310	301 Ti
7	Gland flange				21	Bracket			
	Steel	St37-2	1.0037	283-C		Steel	St37-2 galvanized	1.0037	283-C
	Stainless Steel	X5CrNi18-10	1.4301	304	22	Hex. bolt			
	Stainless Steel	G-X5CrNiMo19-11-2	1.4408	CF8M		Steel	St galvanized		CS
8	Thrust collar				23	Hex. nut			
	Stainless Steel	X5CrNi18-10	1.4301	304		Steel	St galvanized		CS
9	Bearing ring				24	Washer			
	Stainless Steel	X6CrNiMoTi17-12-2	1.4571 chr-pld	316 Ti		Steel	St galvanized		CS
10	Suppor. washer				25	Seal			
	Stainless Steel	X6CrNiMoTi17-12-2	1.4571	316 Ti		Graphite			
11	Taper pin				26	Cover plate			
	Stainless Steel	X4CrNiMo16-5-1	1.4418			Steel	St37-2 galvanized	1.0037	283-C
12	Plug screw DIN 908				27	Hex.-socket screw			
	Stainless Steel	G-X5CrNiMo19-11-2	1.4408	CF8M		Stainless Steel	A2-70	1.4301	B 8
13	Seal				28	Centering piece			
	PTFE					Stainless Steel	X6CrNiMoTi17-12-2	1.4571	316 Ti
	Graphite				29	Countersunk screw			
						Stainless Steel	A 2	1.4301	SS
	Other materials upon request								

Subject to change without notice

HIGH PERFORMANCE BUTTERFLY VALVE HP 111

TORQUE

- The values specified are based on the initial breakaway torque. (disc disengages from seat, torque then drops)

DN [mm]	Size [in]	Operating pressure							
		10 [bar]		16 [bar]		25 [bar]		40 [bar]	
		R-PTFE	Inconel	R-PTFE	Inconel	R-PTFE	Inconel	R-PTFE	Inconel
50-65	2-2½	27	35	28	42	30	58	31	66
80	3	28	55	30	65	34	90	38	100
100	4	51	90	61	100	80	120	93	140
125	5	63	150	83	172	95	220	125	285
150	6	125	170	136	220	168	300	220	360
200	8	205	350	260	430	280	505	*	*
250	10	485	505	550	620	600	860	-	-
300	12	584	740	700	970	855	1280	-	-
350	14	740	815	930	1050	1200	1370	-	-
400	16	1150	1530	1640	2240	2460	2900	-	-
450	18	1150	1700	1750	2500	2700	3500	-	-
500	20	1210	2010	1800	2760	2800	4260	-	-
550	22	3500	3750	4430	4550	6010	6800	-	-
600	24	4000	4500	4600	5740	6200	8080	-	-

* DN 200 PN 16 max. 25 bar

All values in Nm

PRESSURE/TEMPERATURE DIAGRAM

----- Pressure control line for GS-C25 body material and metal seat

— Pressure control line for 1.4408 body material and metal seat

----- Pressure control line for R-PTFE

The diagram illustrates the performance of the standard version of our valve type HP. Valves for higher pressure or deviating temperature are available upon request.

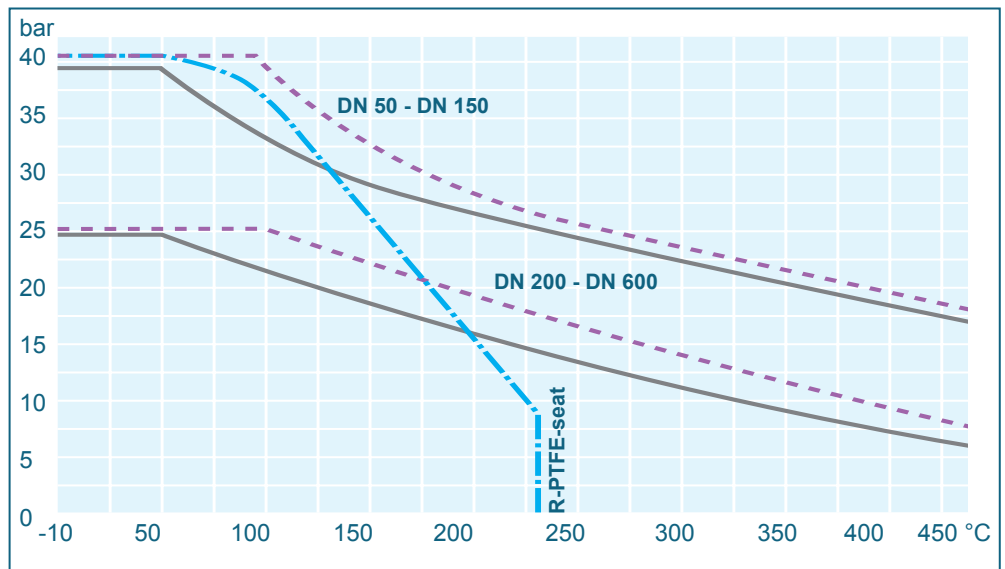

K_v-VALUES

- The K_v-value [m³ per hour] is the flow of water at a temperature of 5°C to 30°C (41°F to 86°F) at Δp of 1 bar

- The K_v-values specified are based on tests carried out by the Delfter Hydraulics Laboratories, the Netherlands

- Permissible velocity of flow
V_{max} 4,5 m/s for liquids,
V_{max} 70 m/s for gases

- The throttle function is linear at an angle 30° to 70°

- Avoid cavitation!

For further values, please contact our engineers.

DN [mm]	Size [in]	Opening angle α°							
		20°	30°	40°	50°	60°	70°	80°	90°
50	2	1,3	6	15	18	19	21	22	23
65	2½	1,5	7	18	22	23	24	25	25
80	3	7	30	50	68	82	97	113	115
100	4	22	60	97	119	164	199	223	251
125	5	45	100	152	195	256	346	452	493
150	6	63	109	162	250	391	588	814	845
200	8	96	168	301	509	742	1107	1581	1747
250	10	264	458	682	980	1421	2083	2882	2889
300	12	397	625	956	1368	1938	2778	3794	3940
350	14	460	720	1100	1650	2500	3400	4800	5400
400	16	550	870	1250	2000	3200	4800	6800	8080
450	18	730	1200	1800	3100	4600	6400	8400	10500
500	20	920	1600	2600	4100	6000	8500	12100	12800
550	22	1090	1950	3100	4600	7500	10200	14700	15300
600	24	1370	2250	3780	4950	9000	12500	17100	18500

Subject to change without notice